

The Grid-50 is a grid structure for relocating events on a glass coverslip. It provides 4 × 400 distinguishable observation squares of 50 μm edge length. The grid is clearly visible by microscopy and imprinted into a microscopy coverslip. The outer dimensions and other parameters are identical to ibidi μ-Dishes.

Geometry of the Grid-50

Geometry of the Grid-500	
Number of squares	4 x 400
Repeat distance	50 μm
Groove width	5 μm (± 1 μm)
Groove depth	< 5 μm

There are four grids numbered from A to D. Each consists of four major squares which are separated in 10 × 10 observation fields and indicated by letters and numbers ranging from:

- A to K (J not used) and 1 to 10
- A to K (J not used) and 11 to 20
- L to U and 1 to 10
- L to U and 11 to 20

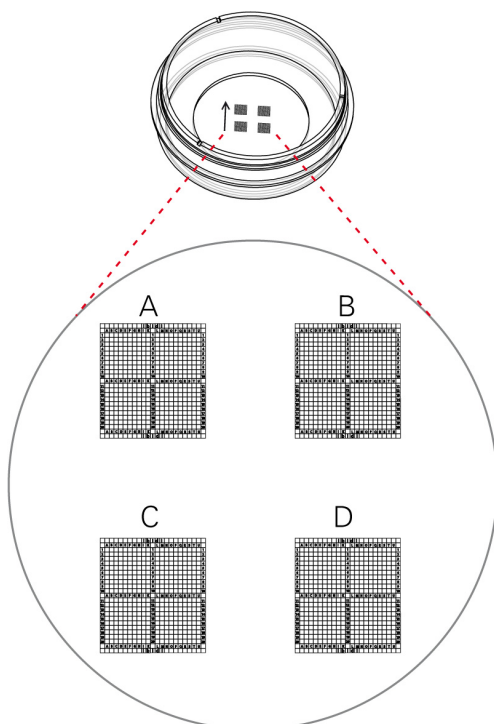

4 x 10 x 10 squares

A

	i b i d i																				
	A	B	C	D	E	F	G	H	I	K	L	M	N	O	P	Q	R	S	T	U	
1											1									1	
2											2									2	
3											3									3	
4											4									4	
5											5									5	
6											6									6	
7											7									7	
8											8									8	
9											9									9	
10											10									10	
	A	B	C	D	E	F	G	H	I	K	L	M	N	O	P	Q	R	S	T	U	
11											11									11	
12											12									12	
13											13									13	
14											14									14	
15											15									15	
16											16									16	
17											17									17	
18											18									18	
19											19									19	
20											20									20	
	A	B	C	D	E	F	G	H	I	K	L	M	N	O	P	Q	R	S	T	U	
	i b i d i																				

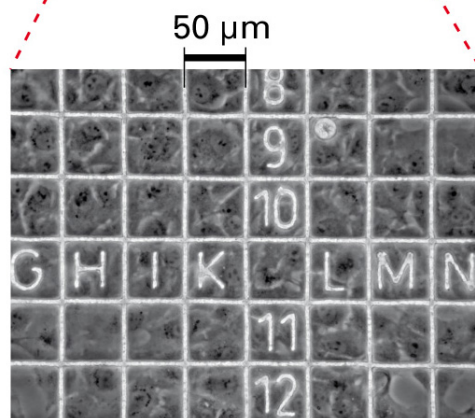

Microscopic image of the grid with rat fibroblast cells (20× objective lens phase contrast).

Characteristics of the Grid

The Grid-50 is made of small grooves that are imprinted into a microscopy coverglass. The structure is imprinted on the side on which cells are growing. Cells and grid are in one focal plane. There is no reported effect on cell growth, coating protocols, or surface properties. Proliferation and cell behavior is comparable to standard non-

Instructions

Grid-50 (ibidi glass bottom)

gridded glass coverslips. Washing steps (e.g. with PBS) before cell seeding can remove glass dust which is advantageous for direct cell growth on the surface.

Please also refer to the instructions of ibidi μ -Dishes glass bottom for information on surfaces, coatings, and cell seeding.

The grooves are 5 μm ($\pm 1 \mu\text{m}$) wide and approximately 5 μm deep. Cells can grow in the grooves as well. We recommend using objective lenses 20 \times or higher.

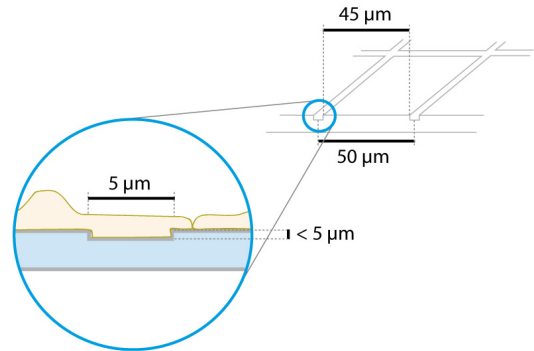

μ -Dish ^{35 mm} Grid family

μ -Dish ^{35 mm, high} with Grid-500

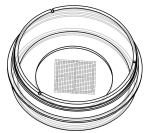

Ordering number	Treatment or Coating	Characteristics
81166	ibiTreat, tissue culture treated, sterile	hydrophilic, tissue culture treated
81161	uncoated, sterile	hydrophobic

μ -Dish ^{35 mm, low} with Grid-500

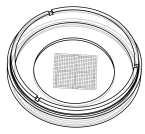

Ordering number	Treatment or Coating	Characteristics
80156	ibiTreat, tissue culture treated, sterile	hydrophilic, tissue culture treated
80151	uncoated, sterile	hydrophobic

μ -Dish ^{35 mm, high} glass bottom with Grid-500

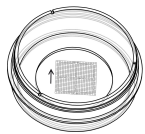

Ordering number	Treatment or Coating	Characteristics
81168	glass bottom, sterile	uncoated glass coverslip

μ -Dish ^{35 mm, high} glass bottom with Grid-50

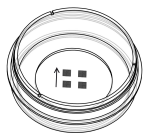

Ordering number	Treatment or Coating	Characteristics
81148	glass bottom, sterile	uncoated glass coverslip

For research use only!

Further technical specifications can be found at www.ibidi.com. For questions and suggestions please contact us by mail info@ibidi.de or by telephone +49 (0)89/520 4617 0. All products are developed and produced in Germany. ©ibidi GmbH, Am Klopferspitz 19, 82152 Martinsried, Germany.